

Features

- Low Voltage and Standard Voltage Operation
 - 2.7 ($V_{CC} = 2.7V$ to 5.5V)
 - 1.8 ($V_{CC} = 1.8V$ to 5.5V)
- Internally Organized 128 x 8
- 2-Wire Serial Interface
- Bidirectional Data Transfer Protocol
- 100 kHz (1.8V, 2.5V, 2.7V) and 400 kHz (5V) Compatibility
- 4-Byte Page Write Mode
- Self-Timed Write Cycle (10 ms max)
- High Reliability
 - Endurance: 1 Million Write Cycles
 - Data Retention: 100 Years
- Automotive Grade, Extended Temperature and Lead-Free Devices Available
- 8-lead PDIP, 8-lead JEDEC SOIC and 8-lead TSSOP Packages

Description

The AT24C01 provides 1024 bits of serial electrically erasable and programmable read only memory (EEPROM) organized as 128 words of 8 bits each. The device is optimized for use in many industrial and commercial applications where low power and low voltage operation are essential. The AT24C01 is available in space saving 8-lead PDIP, 8-lead JEDEC SOIC and 8-lead TSSOP packages and is accessed via a 2-wire serial interface. In addition, the entire family is available in 2.7V (2.7V to 5.5V) and 1.8V (1.8V to 5.5V) versions.

Pin Configurations

Pin Name	Function
NC	No Connect
SDA	Serial Data
SCL	Serial Clock Input
TEST	Test Input (GND or VCC)

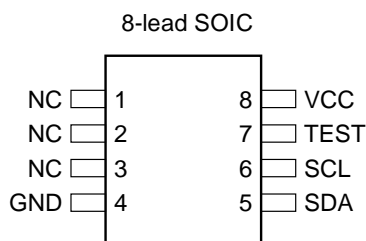
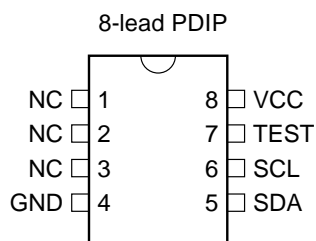
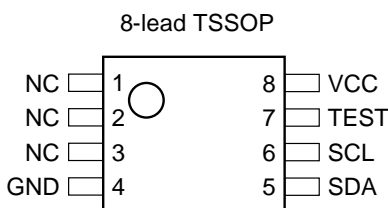

2-Wire Serial EEPROM

1K (128 x 8)

AT24C01



Absolute Maximum Ratings*

Operating Temperature.....	-55°C to +125°C
Storage Temperature.....	-65°C to +150°C
Voltage on Any Pin with Respect to Ground.....	-1.0V to +7.0V
Maximum Operating Voltage.....	6.25V
DC Output Current.....	5.0 mA

*NOTICE: Stresses beyond those listed under “Absolute Maximum Ratings” may cause permanent damage to the device. This is a stress rating only and functional operation of the device at these or any other conditions beyond those indicated in the operational sections of this specification is not implied. Exposure to absolute maximum rating conditions for extended periods may affect device reliability.

Block Diagram

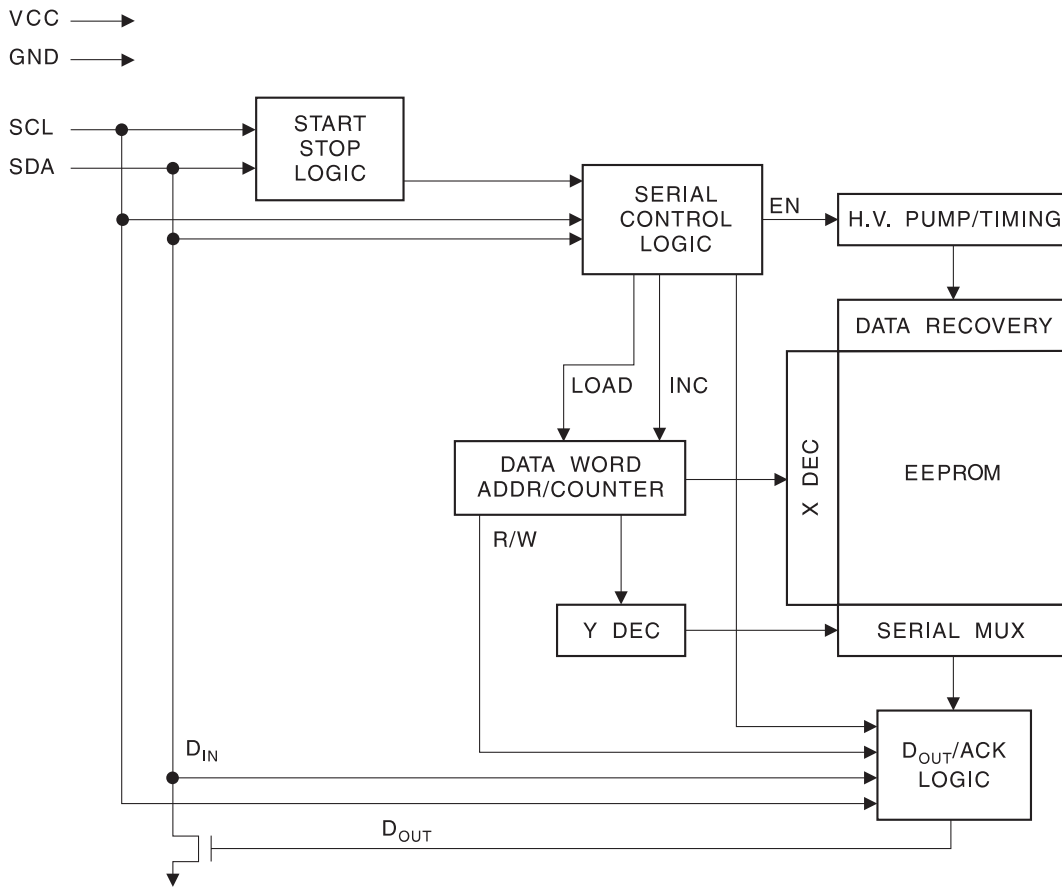

Pin Description

SERIAL CLOCK (SCL): The SCL input is used to positive edge clock data into each EEPROM device and negative edge clock data out of each device.

SERIAL DATA (SDA): The SDA pin is bidirectional for serial data transfer. This pin is open-drain driven and may be wire-ORed with any number of other open-drain or open collector devices.

Memory Organization AT24C01, 1K SERIAL EEPROM: Internally organized with 128 pages of 1 byte each. The 1K requires a 7-bit data word address for random word addressing.

Pin Capacitance

Applicable over recommended operating range from $T_A = 25^\circ\text{C}$, $f = 1.0\text{ MHz}$, $V_{CC} = +1.8\text{V}$.

Symbol	Test Condition	Max	Units	Condition
$C_{I/O}$	Input/Output Capacitance (SDA)	8	pF	$V_{I/O} = 0\text{V}$
C_{IN}	Input Capacitance (A0, A1, A2, SCL)	6	pF	$V_{IN} = 0\text{V}$

DC Characteristics

Applicable over recommended operating range from: $T_{AI} = -40^\circ\text{C}$ to $+85^\circ\text{C}$, $V_{CC} = +1.8\text{V}$ to $+5.5\text{V}$, $T_{AE} = -40^\circ\text{C}$ to $+125^\circ\text{C}$, $V_{CC} = +1.8\text{V}$ to $+5.5\text{V}$ (unless otherwise noted).

Symbol	Parameter	Test Condition	Min	Typ	Max	Units
V_{CC1}	Supply Voltage		1.8		5.5	V
V_{CC2}	Supply Voltage		2.5		5.5	V
V_{CC3}	Supply Voltage		2.7		5.5	V
V_{CC4}	Supply Voltage		4.5		5.5	V
I_{CC}	Supply Current $V_{CC} = 5.0\text{V}$	READ at 100 kHz		0.4	1.0	mA
I_{CC}	Supply Current $V_{CC} = 5.0\text{V}$	WRITE at 100 kHz		2.0	3.0	mA
I_{SB1}	Standby Current $V_{CC} = 1.8\text{V}$	$V_{IN} = V_{CC}$ or V_{SS}		0.6	3.0	μA
I_{SB2}	Standby Current $V_{CC} = 2.5\text{V}$	$V_{IN} = V_{CC}$ or V_{SS}		1.4	4.0	μA
I_{SB3}	Standby Current $V_{CC} = 2.7\text{V}$	$V_{IN} = V_{CC}$ or V_{SS}		1.6	4.0	μA
I_{SB4}	Standby Current $V_{CC} = 5.0\text{V}$	$V_{IN} = V_{CC}$ or V_{SS}		8.0	18.0	μA
I_{LI}	Input Leakage Current	$V_{IN} = V_{CC}$ or V_{SS}		0.10	3.0	μA
I_{LO}	Output Leakage Current	$V_{OUT} = V_{CC}$ or V_{SS}		0.05	3.0	μA
V_{IL}	Input Low Level ⁽¹⁾		-0.6		$V_{CC} \times 0.3$	V
V_{IH}	Input High Level ⁽¹⁾		$V_{CC} \times 0.7$		$V_{CC} + 0.5$	V
V_{OL2}	Output Low Level $V_{CC} = 3.0\text{V}$	$I_{OL} = 2.1\text{ mA}$			0.4	V
V_{OL1}	Output Low Level $V_{CC} = 1.8\text{V}$	$I_{OL} = 0.15\text{ mA}$			0.2	V

Note: 1. V_{IL} min and V_{IH} max are reference only and are not tested.

AC Characteristics

Applicable over recommended operating range from $T_{AI} = -40^{\circ}\text{C}$ to $+85^{\circ}\text{C}$, $T_{AE} = -40^{\circ}\text{C}$ to $+125^{\circ}\text{C}$, $V_{CC} = +1.8\text{V}$ to $+5.5\text{V}$, $CL = 1$ TTL Gate and 100 pF (unless otherwise noted).

Symbol	Parameter	2.7-, 2.5-, 1.8-volt		5.0-volt		Units
		Min	Max	Min	Max	
f_{SCL}	Clock Frequency, SCL		100		400	kHz
t_{LOW}	Clock Pulse Width Low	4.7		1.2		μs
t_{HIGH}	Clock Pulse Width High	4.0		0.6		μs
t_I	Noise Suppression Time ⁽¹⁾		100		50	ns
t_{AA}	Clock Low to Data Out Valid	0.1	4.5	0.1	0.9	μs
t_{BUF}	Time the bus must be free before a new transmission can start ⁽¹⁾	4.7		1.2		μs
$t_{HD,STA}$	Start Hold Time	4.0		0.6		μs
$t_{SU,STA}$	Start Set-up Time	4.7		0.6		μs
$t_{HD,DAT}$	Data In Hold Time	0		0		μs
$t_{SU,DAT}$	Data In Set-up Time	200		100		ns
t_R	Inputs Rise Time ⁽¹⁾		1.0		0.3	μs
t_F	Inputs Fall Time ⁽¹⁾		300		300	ns
$t_{SU,STO}$	Stop Set-up Time	4.7		0.6		μs
t_{DH}	Data Out Hold Time	100		50		ns
t_{WR}	Write Cycle Time		10		10	ms
Endurance ⁽¹⁾	5.0V, 25°C, Page Mode	1M		1M		Write Cycles

Note: 1. This parameter is characterized and is not 100% tested.

Device Operation

CLOCK and DATA TRANSITIONS: The SDA pin is normally pulled high with an external device. Data on the SDA pin may change only during SCL low time periods (refer to Data Validity timing diagram). Data changes during SCL high periods will indicate a start or stop condition as defined below.

START CONDITION: A high-to-low transition of SDA with SCL high is a start condition which must precede any other command (refer to Start and Stop Definition timing diagram).

STOP CONDITION: A low-to-high transition of SDA with SCL high is a stop condition which terminates all communications. After a read sequence, the stop command will place the EEPROM in a standby power mode (refer to Start and Stop Definition timing diagram).

ACKNOWLEDGE: All addresses and data words are serially transmitted to and from the EEPROM in 8-bit words. Any device on the system bus receiving data (when communicating with the EEPROM) must pull the SDA bus low to acknowledge that it has successfully received each word. This must happen during the ninth clock cycle after each word received and after all other system devices have freed the SDA bus. The EEPROM will likewise acknowledge by pulling SDA low after receiving each address or data word (refer to Acknowledge Response from Receiver timing diagram).

STANDBY MODE: The AT24C01 features a low power standby mode which is enabled: (a) upon power-up and (b) after the receipt of the STOP bit and the completion of any internal operations.

MEMORY RESET: After an interruption in protocol, power loss or system reset, any 2-wire part can be reset by following these steps:

(a) Clock up to 9 cycles, (b) look for SDA high in each cycle while SCL is high and then (c) create a start condition as SDA is high.

Bus Timing

SCL: Serial Clock, SDA: Serial Data I/O

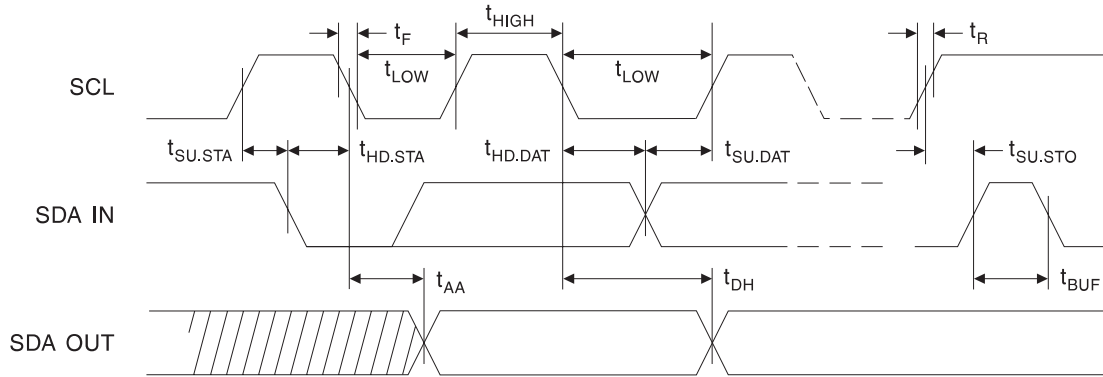

Write Cycle Timing

SCL: Serial Clock, SDA: Serial Data I/O

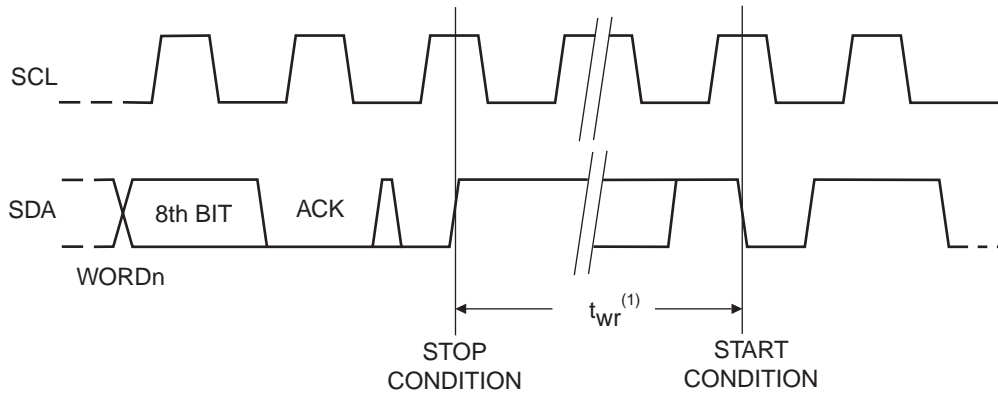

Note: 1. The write cycle time t_{wr} is the time from a valid stop condition of a write sequence to the end of the internal clear/write cycle.

Data Validity

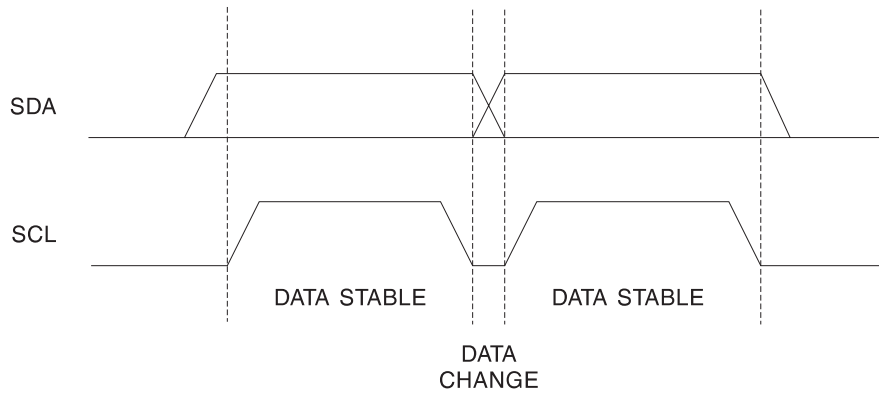

Start and Stop Definition

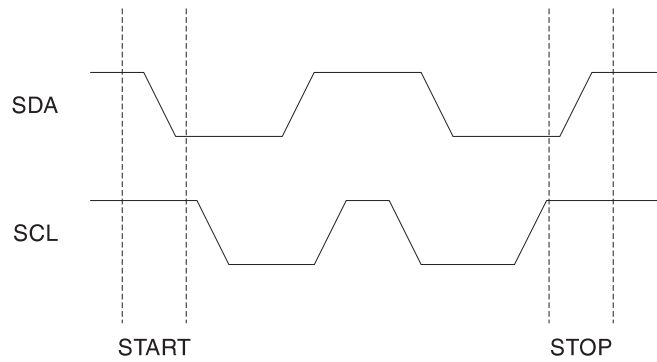

Output Acknowledge

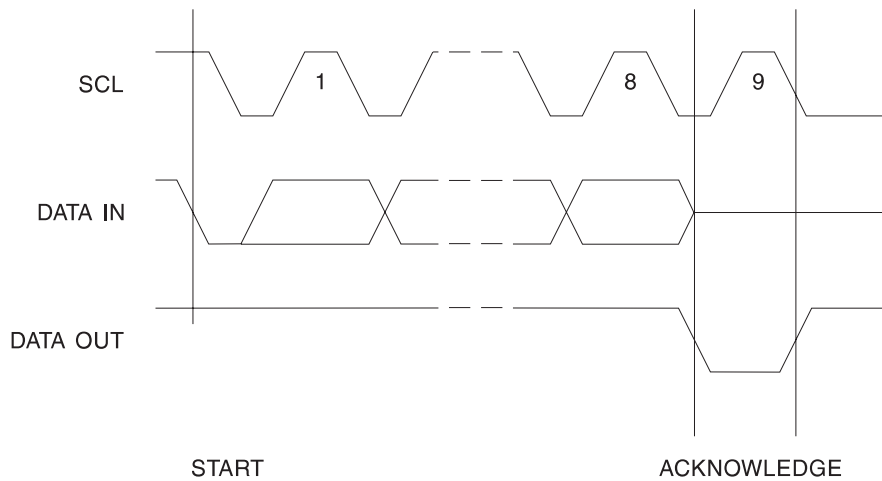

Write Operations

BYTE WRITE: Following a start condition, a write operation requires a 7-bit data word address and a low write bit. Upon receipt of this address, the EEPROM will again respond with a zero and then clock in the first 8-bit data word. Following receipt of the 8-bit data word, the EEPROM will output a zero and the addressing device, such as a microcontroller, must terminate the write sequence with a stop condition. At this time the EEPROM enters an internally-timed write cycle to the nonvolatile memory. All inputs are disabled during this write cycle, t_{WR} , and the EEPROM will not respond until the write is complete (refer to Figure 1).

PAGE WRITE: The AT24C01 is capable of a 4-byte page write.

A page write is initiated the same as a byte write but the microcontroller does not send a stop condition after the first data word is clocked in. Instead, after the EEPROM acknowledges receipt of the first data word, the microcontroller can transmit up to three more data words. The EEPROM will respond with a zero after each data word received. The microcontroller must terminate the page write sequence with a stop condition (refer to Figure 2).

The data word address lower 2 bits are internally incremented following the receipt of each data word. The higher five data word address bits are not incremented, retaining the memory page row location. When the word address, internally generated, reaches the page boundary, the following byte is placed at the beginning of the same page. If more than four data words are transmitted to the EEPROM, the data word address will “roll over” and previous data will be overwritten.

ACKNOWLEDGE POLLING: Once the internally-timed write cycle has started and the EEPROM inputs are disabled, acknowledge polling can be initiated. This involves sending a start condition followed by the device address word. The read/write bit is representative of the operation desired. Only if the internal write cycle has completed will the EEPROM respond with a zero allowing the read or write sequence to continue.

Read Operations

Read operations are initiated the same way as write operations with the exception that the read/write select bit in the device address word is set to one. There are two read operations: byte read and sequential read.

BYTE READ: A byte read is initiated with a start condition followed by a 7-bit data word address and a high read bit. The AT24C01 will respond with an acknowledge and then serially output 8 data bits. The microcontroller does not respond with a zero but does generate a following stop condition (refer to Figure 3).

SEQUENTIAL READ: Sequential reads are initiated the same as a byte read. After the microcontroller receives an 8-bit data word, it responds with an acknowledge. As long as the EEPROM receives an acknowledge, it will continue to increment the data word address and serially clock out sequential data words. When the memory address limit is reached, the data word address will “roll over” and the sequential read will continue. The sequential read operation is terminated when the microcontroller does not respond with an input zero but does generate a following stop condition (refer to Figure 4).

Figure 1. Byte Write

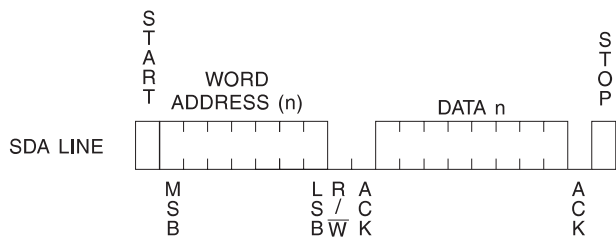

Figure 2. Page Write

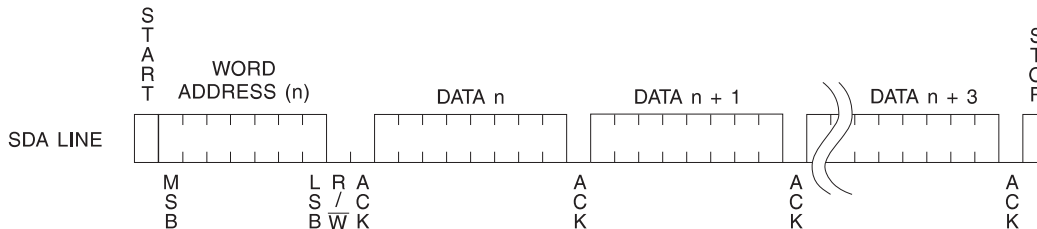

Figure 3. Byte Read

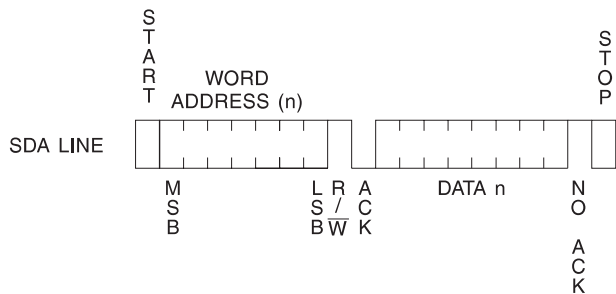
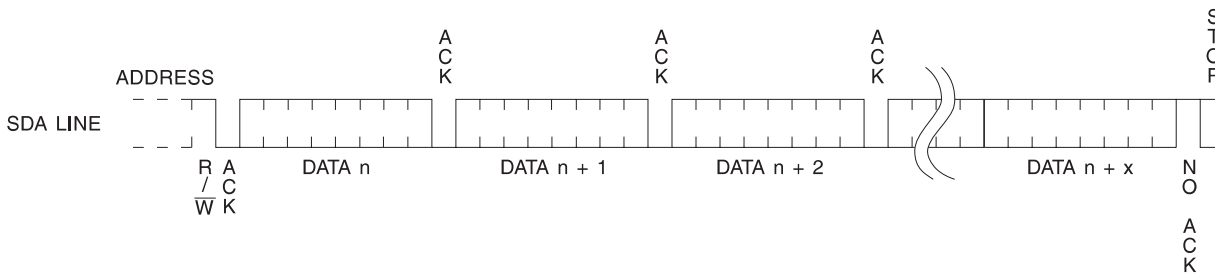

Figure 4. Sequential Read





Ordering Information

Ordering Code	Package	Operation Range
AT24C01-10PI-2.7	8P3	Industrial
AT24C01-10SI-2.7	8S1	(-40°C to 85°C)
AT24C01-10TI-2.7	8A2	
AT24C01-10PI-1.8	8P3	Industrial
AT24C01-10SI-1.8	8S1	(-40°C to 85°C)
AT24C01-10TI-1.8	8A2	
AT24C01-10SJ-2.7	8S1	Lead-Free/Industrial Temperature
AT24C01-10SJ-1.8	8S1	(-40°C to 85°C)
AT24C01-10SE-2.7	8S1	High Grade/Extended Temperature
		(-40°C to 125°C)

Note: For 2.7V devices used in the 4.5V to 5.5V range, please refer to performance values in the AC and DC Characteristics tables.

Package Type	
8P3	8-lead, 0.300" Wide, Plastic Dual Inline Package (PDIP)
8S1	8-lead, 0.150" Wide, Plastic Gull Wing Small Outline (JEDEC SOIC)
8A2	8-lead, 0.170" Wide, Thin Shrink Small Outline Package (TSSOP)
Options	
-2.7	Low-Voltage (2.7V to 5.5V)
-1.8	Low-Voltage (1.8V to 5.5V)

Packaging Information

8P3 – PDIP

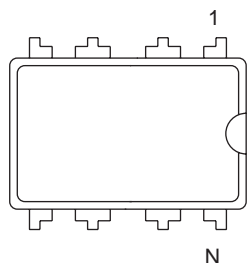

Top View

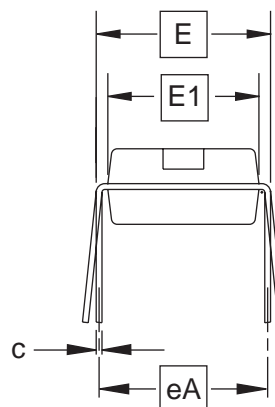

End View

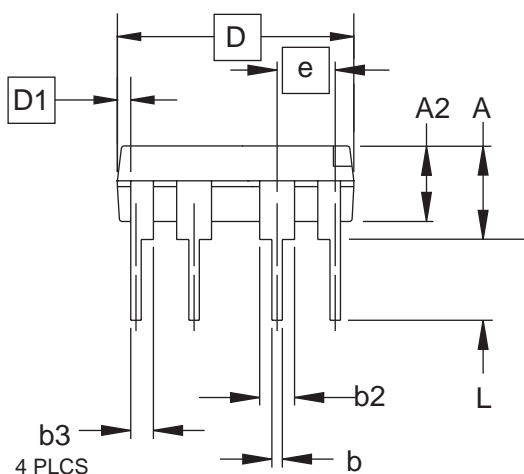

Side View

COMMON DIMENSIONS
(Unit of Measure = inches)

SYMBOL	MIN	NOM	MAX	NOTE
A			0.210	2
A2	0.115	0.130	0.195	
b	0.014	0.018	0.022	5
b2	0.045	0.060	0.070	6
b3	0.030	0.039	0.045	6
c	0.008	0.010	0.014	
D	0.355	0.365	0.400	3
D1	0.005			3
E	0.300	0.310	0.325	4
E1	0.240	0.250	0.280	3
e	0.100 BSC			
eA	0.300 BSC			4
L	0.115	0.130	0.150	2

- Notes:
1. This drawing is for general information only; refer to JEDEC Drawing MS-001, Variation BA for additional information.
 2. Dimensions A and L are measured with the package seated in JEDEC seating plane Gauge GS-3.
 3. D, D1 and E1 dimensions do not include mold Flash or protrusions. Mold Flash or protrusions shall not exceed 0.010 inch.
 4. E and eA measured with the leads constrained to be perpendicular to datum.
 5. Pointed or rounded lead tips are preferred to ease insertion.
 6. b2 and b3 maximum dimensions do not include Dambar protrusions. Dambar protrusions shall not exceed 0.010 (0.25 mm).

01/09/02



2325 Orchard Parkway
San Jose, CA 95131

TITLE
8P3, 8-lead, 0.300" Wide Body, Plastic Dual
In-line Package (PDIP)

DRAWING NO.
8P3

REV.
B



8S1 – JEDEC SOIC

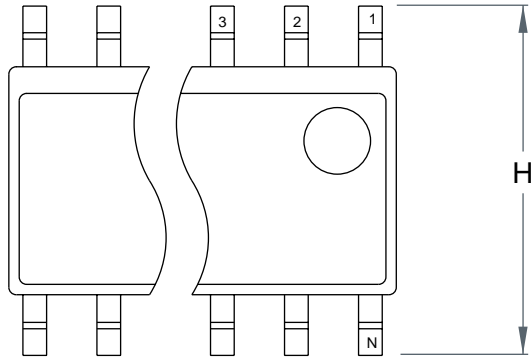

Top View

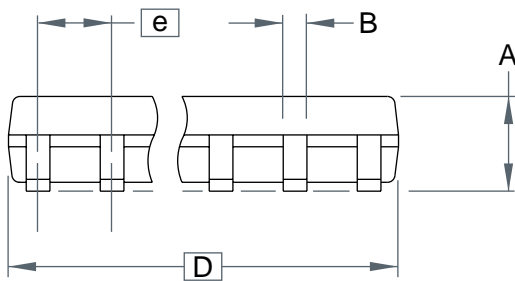

Side View

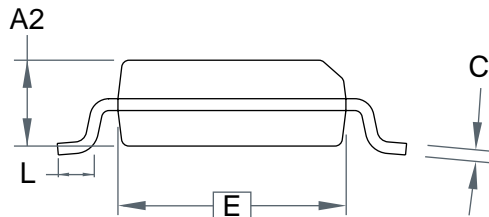

End View

COMMON DIMENSIONS
(Unit of Measure = mm)

SYMBOL	MIN	NOM	MAX	NOTE
A	–	–	1.75	
B	–	–	0.51	
C	–	–	0.25	
D	–	–	5.00	
E	–	–	4.00	
e	1.27 BSC			
H	–	–	6.20	
L	–	–	1.27	

Note: This drawing is for general information only. Refer to JEDEC Drawing MS-012 for proper dimensions, tolerances, datums, etc.

10/10/01



2325 Orchard Parkway
San Jose, CA 95131

TITLE
8S1, 8-lead (0.150" Wide Body), Plastic Gull Wing
Small Outline (JEDEC SOIC)

DRAWING NO.
8S1

REV.
A

8A2 – TSSOP

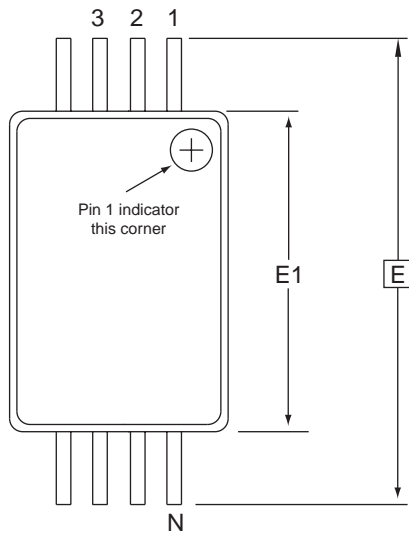

Top View

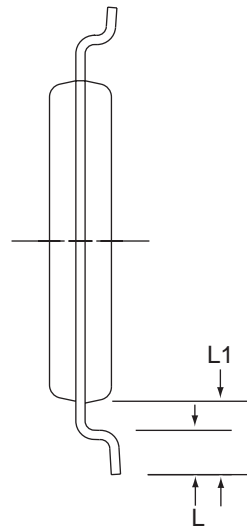

End View

COMMON DIMENSIONS
(Unit of Measure = mm)

SYMBOL	MIN	NOM	MAX	NOTE
D	2.90	3.00	3.10	2, 5
E	6.40 BSC			
E1	4.30	4.40	4.50	3, 5
A	-	-	1.20	
A2	0.80	1.00	1.05	
b	0.19	-	0.30	4
e	0.65 BSC			
L	0.45	0.60	0.75	
L1	1.00 REF			

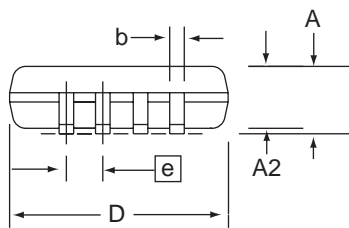

Side View

- Notes:
1. This drawing is for general information only. Refer to JEDEC Drawing MO-153, Variation AA, for proper dimensions, tolerances, datums, etc.
 2. Dimension D does not include mold Flash, protrusions or gate burrs. Mold Flash, protrusions and gate burrs shall not exceed 0.15 mm (0.006 in) per side.
 3. Dimension E1 does not include inter-lead Flash or protrusions. Inter-lead Flash and protrusions shall not exceed 0.25 mm (0.010 in) per side.
 4. Dimension b does not include Dambar protrusion. Allowable Dambar protrusion shall be 0.08 mm total in excess of the b dimension at maximum material condition. Dambar cannot be located on the lower radius of the foot. Minimum space between protrusion and adjacent lead is 0.07 mm.
 5. Dimension D and E1 to be determined at Datum Plane H.

5/30/02



2325 Orchard Parkway
San Jose, CA 95131

TITLE
8A2, 8-lead, 4.4 mm Body, Plastic
Thin Shrink Small Outline Package (TSSOP)

DRAWING NO.
8A2

REV.
B





Atmel Corporation

USA

2325 Orchard Parkway
San Jose, CA 95131
Tel: 1(408) 441-0311
Fax: 1(408) 487-2600

Regional Headquarters

Europe

Atmel Sarl
Route des Arsenaux 41
Case Postale 80
CH-1705 Fribourg
Switzerland
Tel: (41) 26-426-5555
Fax: (41) 26-426-5500

Asia

Room 1219
Chinachem Golden Plaza
77 Mody Road Tsimshatsui
East Kowloon
Hong Kong
Tel: (852) 2721-9778
Fax: (852) 2722-1369

Japan

9F, Tonetsu Shinkawa Bldg.
1-24-8 Shinkawa
Chuo-ku, Tokyo 104-0033
Japan
Tel: (81) 3-3523-3551
Fax: (81) 3-3523-7581

Atmel Operations

Memory

2325 Orchard Parkway
San Jose, CA 95131
Tel: 1(408) 441-0311
Fax: 1(408) 436-4314

Microcontrollers

2325 Orchard Parkway
San Jose, CA 95131
Tel: 1(408) 441-0311
Fax: 1(408) 436-4314

La Chantrerie
BP 70602
44306 Nantes Cedex 3, France
Tel: (33) 2-40-18-18-18
Fax: (33) 2-40-18-19-60

ASIC/ASSP/Smart Cards

Zone Industrielle
13106 Rousset Cedex, France
Tel: (33) 4-42-53-60-00
Fax: (33) 4-42-53-60-01

1150 East Cheyenne Mtn. Blvd.
Colorado Springs, CO 80906
Tel: 1(719) 576-3300
Fax: 1(719) 540-1759

Scottish Enterprise Technology Park
Maxwell Building
East Kilbride G75 0QR, Scotland
Tel: (44) 1355-803-000
Fax: (44) 1355-242-743

RF/Automotive

Theresienstrasse 2
Postfach 3535
74025 Heilbronn, Germany
Tel: (49) 71-31-67-0
Fax: (49) 71-31-67-2340

1150 East Cheyenne Mtn. Blvd.
Colorado Springs, CO 80906
Tel: 1(719) 576-3300
Fax: 1(719) 540-1759

Biometrics/Imaging/Hi-Rel MPU/ High Speed Converters/RF Datacom

Avenue de Rochepleine
BP 123
38521 Saint-Egreve Cedex, France
Tel: (33) 4-76-58-30-00
Fax: (33) 4-76-58-34-80

Literature Requests

www.atmel.com/literature

Disclaimer: Atmel Corporation makes no warranty for the use of its products, other than those expressly contained in the Company's standard warranty which is detailed in Atmel's Terms and Conditions located on the Company's web site. The Company assumes no responsibility for any errors which may appear in this document, reserves the right to change devices or specifications detailed herein at any time without notice, and does not make any commitment to update the information contained herein. No licenses to patents or other intellectual property of Atmel are granted by the Company in connection with the sale of Atmel products, expressly or by implication. Atmel's products are not authorized for use as critical components in life support devices or systems.

© Atmel Corporation 2003. All rights reserved. Atmel® and combinations thereof, are the registered trademarks of Atmel Corporation or its subsidiaries. Other terms and product names may be the trademarks of others.



Printed on recycled paper.